



PDM

Power Drive
Heavy-Duty
Straddle Trucks



BIGJOE[®]

The logo consists of a stylized yellow and black symbol above the word "BIGJOE" in a bold, sans-serif font. A registered trademark symbol (®) is located to the right of the word.

The Heavyweight Medium-Duty Straddle Truck

The PDM gives heavy-duty performance for a medium-duty price. This truck has the same structure and drive train as our heavier full duty-cycle units. The medium-duty designation refers only to the time the truck can operate between battery charging. PDM is the lift truck built for those who have a need for a power propelled, power lift truck who do not use it continuously over multiple shifts.

The PDM is excellent for "retail" applications where selling space is primary and back rooms are small, confined spaces. PDM functions well in tight areas yet has the capacity to transport heavy skids to the floor area for stocking. This series is designed and built for loading, off-loading, inter-department handling and various warehouse storage functions. The capacity ranges from 2,000 to 3,000 pounds. Available with full free lift and adjustable straddles.

Construction, features and versatility make the PDM an exceptional value for a Walkie Straddle lift truck.





POWER DRIVE MEDIUM-DUTY STRADDLE TRUCKS

STANDARD EQUIPMENT

■ **Channel and I-Beam Mast.** High grade steel mast construction features interlocked channel and I-beam design with roller bearing surfaces. Mast and carriage is of fully-rollered construction for smooth, long-wearing performance. This type of construction accommodates high lifting stresses and maintains load stability.

■ **Direction Reversing “Belly-Button” Impact Switch.** A reversing switch, built into the control handle is designed to reverse truck direction on contact with the operator.

■ **Fully Protected Electrical System.** Fully fuse protected, heavy-duty 100 ampere industrial contactors are standard. All wiring is coded for easy servicing.

■ **Battery Charger.** Internally mounted fully automatic “smart” charger provides amount of charge necessary. Plugs into standard 110 volt AC outlet.

■ **Versatile Braking Systems.** Two-way mechanical brake in top and bottom 15° of handle arc actuates automotive-type disc brake proportional to handle movement, allowing operator complete control of braking from “feathering” through full emergency stop. When released, handle returns to upright position and applies the brake.

- Dynamic Brake, actuated by a pushbutton on the control handle provides electrical braking for accurate payload positioning and protection.

■ **Industrial Rated Batteries.** Built to withstand deep-discharge and recharging, industrial rated batteries contain heavy plates and separators. Externally mounted quick-release battery disconnect is readily accessible to remove all power from truck circuits in the event of an emergency. Hinged battery compartment covers provide easy access to batteries for maintenance.

■ **High Strength Construction.** Unitized seam-welded steel frame resists operational stresses and provides a rugged housing to protect truck components.

■ **Advanced Handle Control.** Models come equipped with the industry’s most versatile control handle. Speed may be controlled with twist grip or thumb control. Includes 3-speed forward and reverse detent action speed control; thumb control of horn and dynamic brake.

■ **Chrome Plated Lift Cylinder.** Provides smooth lift/lower operation and maintenance-free long cylinder life.

■ **Pressure-Compensated Flow Control Valve.** Located at base of lift cylinder, regulates lowering speed (on telescopic models only).

■ **V-Boxed Load Wheels on Straddle Legs.** This improved straddle leg design not only protects load wheels, but its angular shape aids in pushing empty pallets or other obstructions to the side and away from the truck’s work path.

OPTIONS (other options available, consult factory)

■ **Adjustable Straddle Option.** Available for the straddle I.D. range of 38” to 50”. Adjusts in 4” increments. Will allow the truck to work with a variety of pallet sizes. Ideal if future pallet requirements may change.

■ **Full Free Lift.** Allows fork carriage to extend to the top of the first stage before the second stage begins to extend. For lifting in areas limited by overhead clearance. Reduces lift and collapsed height 2” (consult factory).

■ **Stepless Speed Control.** Infinitely variable speed control is available.



SPECIFICATIONS

- Lifting Capacity:** 2,000 to 3,000 lbs. at 24” load centers
- Lift Range:** 60” - 154”
- Power System:** 12 volt
- Turning Radius:** From 58”
- Travel:** 3 speeds forward and reverse
(infinitely variable speed control available)
- BATTERY:**
- PDM 20 & 25: Two 12V batteries in parallel, 310 amp pack
 - PDM 30: Two 12V batteries in parallel, 400 amp pack
- Compartments:** Two 7¹/₄” x 18¹/₄” x 16” high
- CHARGER:** 12V, 30 amp fully automatic “smart” charger
- Fork Length x Width x Thickness:**
- PDM 20 & 25: 36” or 42” x 4” x 1¹/₄”
 - PDM 30: 36” or 42” x 4” x 1¹/₂”
- Fork Lowered Ht.:** 2” (min.)
- Fork OD Range:** 6” (min.), 28” (max.)
- WHEELS:**
- Drive (Standard):** 10” Dia. x 4” wide, rubber
 - Load:**
 - PDM 20 & 25: Single 4” dia. x 2³/₄” wide, polyurethane
 - PDM 30: Dual 4” dia. x 2³/₄” wide polyurethane
 - Caster:** 4” dia. x 2” wide polyurethane
- Clearance:** 1¹/₂” floor to bottom of straddle
- Free Lift:** 57³/₄” non-telescopic 12” telescopic
- Optional Full Free Lift:** 51³/₄” for 106” lift ht. 63³/₄” for 130” lift ht.

Performance:	PDM20	PDM25	PDM30
Lift Speed (FPM)			
Empty	26.6	26.6	26.6
Loaded	16.5	14.9	12.8
Lowering Speed (FPM)			
Empty	27.5	27.5	27.5
Loaded	32.5	34.9	36.3
Travel Speed (MPH)			
Empty	2.8	2.8	2.8
Loaded	2.4	2.3	2.2
Gradeability	10%	10%	10%
Grade Clearance	11%	11%	10%

DIMENSIONS

LOAD LENGTH	RIGHT ANGLE STACKING			
	LOAD WIDTH			
	36"	40"	42"	48"
36"	70"	71"	72"	74"
42"	70"	71"	72"	74"
48"	70"	71"	72"	74"

Aisle dimensions are zero clearance; 12" should be add for efficient operation.

Aisle dimensions assume bay width to be the straddle O.D. plus 12" (1" on each side) where straddle O.D. is the load width plus 10".

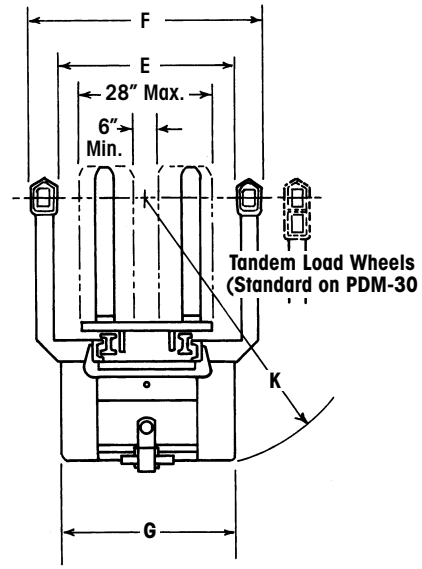
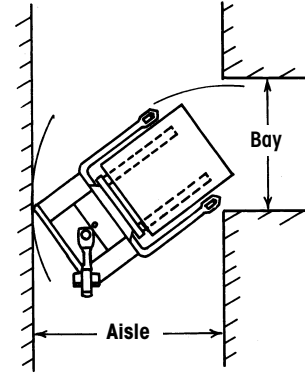
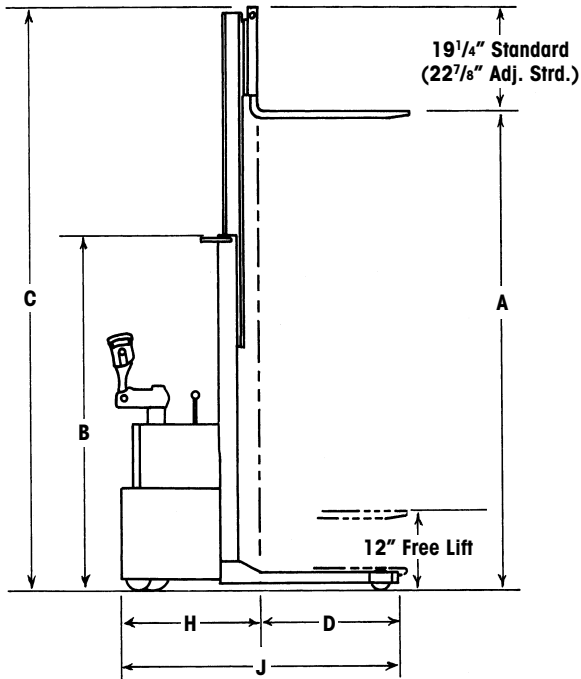

MODEL NO.	CAPACITY AT 24" LOAD CENTER	LIFT HT. A	COLL. HT. * B	EXT. HT. * C	STRADDLES			POWER HEAD WIDTH G	POWER HEAD LENGHT *** H	OVERALL LENGHT J	TURN RADIUS K	APPROXIMATE SHPG. WEIGHT W/BATTERIES
					LENGTH ** D	ID E	OD F					
PDM-20 SERIES												
NON-TELESCOPIC												
PDM-20-60	2000	60	77	79 1/4	28 5/8	42	50	36	29 3/8	58	58	1480
TELESCOPIC												
PDM-20-106	2000	106	71	125 1/4	28 5/8	42	50	36	29 3/8	58	58	1830
PDM-20-130	2000	130	83	149 1/4	28 5/8	42	50	36	29 3/8	58	58	1910
PDM-20-154	2000	154	95	173 1/4	28 5/8	42	50	36	29 3/8	58	58	1990
PDM-25 SERIES												
NON-TELESCOPIC												
PDM-25-60	2500	60	77	79 1/4	28 5/8	42	50	36	29 3/8	58	58	1540
TELESCOPIC												
PDM-25-106	2500	106	71	125 1/4	28 5/8	42	50	36	29 3/8	58	58	1890
PDM-25-130	2500	130	83	149 1/4	28 5/8	42	50	36	29 3/8	58	58	1970
PDM-25-154	2500	154	95	173 1/4	28 5/8	42	50	36	29 3/8	58	58	2050
PDM-30 SERIES												
NON-TELESCOPIC												
PDM-30-60	3000	60	77	79 1/4	28 5/8	42	50	36	29 3/8	58	58	1555
TELESCOPIC												
PDM-30-106	3000	106	71	125 1/4	28 5/8	42	50	36	29 3/8	58	58	1905
PDM-30-130	3000	130	83	149 1/4	28 5/8	42	50	36	29 3/8	58	58	1985
PDM-30-154	3000	154	95	173 1/4	28 5/8	42	50	36	29 3/8	58	58	2065

*For adjustable straddles add 3 5/8"

**Face of fork to end of load wheels.

***To face of fork.

PDM

POWER DRIVE MEDIUM-DUTY STRADDLE TRUCKS

TECHNICAL DATA

ELECTRICAL SYSTEM

All power is routed via an "SB" type connector (standard) to primary fuse protection, where power then is separated to drive, lift and control system subcircuits.

Modular drive control panel has premium, industrial-grade contactors with replaceable silver-alloy tips.

All cables and wiring are coded for easy servicing.

High-torque, class H insulated drive motor has copper-graphitic brushes for peak electrical efficiency and long life.

Hydraulic pump motor is specially selected for peak electrical efficiency at specific torque and rpm lift pump requirements.

Drive control circuits are routed to the control head via multiple conductor cable.

Control circuits are fuse-protected, numbered, and terminate in plug-in type connectors.

PDM-20, -25: 12 volt, 310 amp hour battery pack (2 x 155 AH) and 30 amp built-in fully automatic "smart" charger.

PDM-30: 12 volt, 400 amp hour battery pack (2 x 200 AH) and 30 amp built-in fully automatic "smart" charger.

STRUCTURAL SYSTEM

Mast construction is interlocked channel and I-Beam, rolled specifically for lift truck use.

Fully rollered inner mast and lift carriage.

Unitized construction chassis, mast, and straddles form an integral, welded steel structure built to take operational stresses. All surfaces prone to receive accidental impact are heavy gauge steel. Continuous-seam welding is used throughout the chassis.

2000 lb. / 2500 lb. capacity forks — 1.25 thick x 4" wide alloy steel forged forks bottom taper of 14" and beveled fork tips.

3000 lb. capacity forks — 1.50 thick x 4" wide alloy steel forged forks bottom taper of 14" and beveled fork tips.

DRIVE SYSTEM

The entire drive train steers the truck via a bearing-mounted pivot tube. Coil-spring suspension provides constant traction. Heavy-duty casters support variable weight for consistent steering effort regardless of pay-load size.

Disc brake is mounted to drive motor armature. This arrangement multiplies the braking force by the 22:1 transmission ratio, providing effective stopping action.

Direct drive, full oil bath transmission, operates through 22:1 gear reduction in ductile-iron transmission case with heat-treated spur gears and premium industrial bearings.

HYDRAULIC SYSTEM

Infinitely variable ball-type lowering valve provides full-range operator control and no-drift, positive system check in neutral.

Gear pumps are mated to lift cylinders to provide efficient lift performance at modest power-draw levels.

Full system filtration is provided on the intake side of the pump which prevents foreign matter from entering the system.

Built-in relief valve protects system from overload.

Pressure-compensated flow control valve at base of lift cylinder regulates lowering speed.

Reservoir is removable, and comes equipped with foam-filter cap and dipstick.

SAFETY FEATURES

Automatic high-speed cut-off circuit locks out 3rd speed when forks are elevated above 18".

"Belly-button" switch provides operator protection when maneuvering. Upon body contact, switch activates low speed in the opposite direction.

Slip-resistant handgrips provide firm control of steering arm.

"Dead-man" braking occurs when spring loaded control handle is released and returns to upright position, turning off electrical power and applying disc brake.

Externally mounted battery disconnect is accessible to the operator for emergency power interrupt.

All power and control circuits are fuse-protected.

CERTIFICATION

All units are certified to be in compliance with the Occupational Safety and Health Act (OSHA).

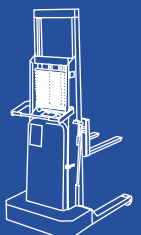
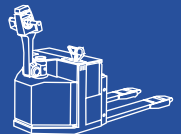
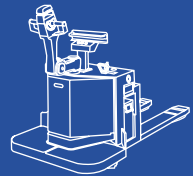
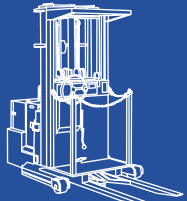
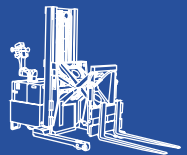
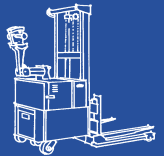
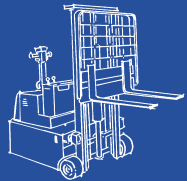
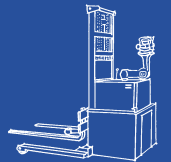
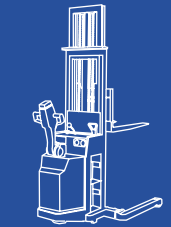

Big Joe Manufacturing Company

7225 N. Kostner Avenue, Lincolnwood, IL 60712

847-675-8700 • FAX 847-675-7204

Big Joe Manufacturing Company will not assume liability for injuries or damage arising from, or caused by, the removal of any safety devices from their vehicles by user. Because of the Big Joe policy of continuing product improvements, specifications are subject to change without notice.